

Julia 40 (400x400)

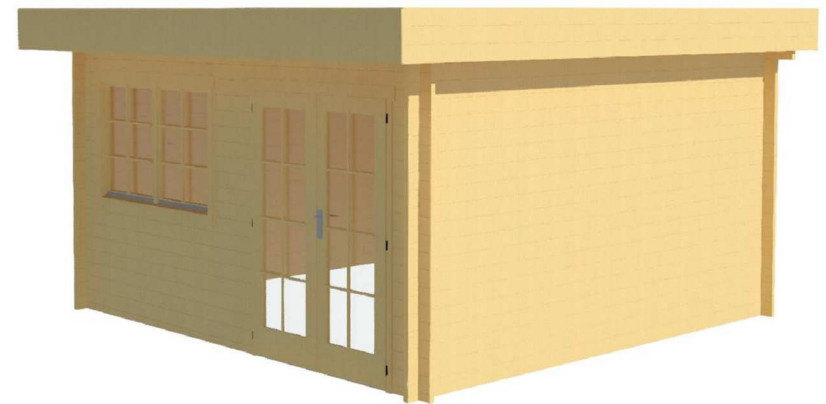

Julia 40 (400x400)

Wall 1

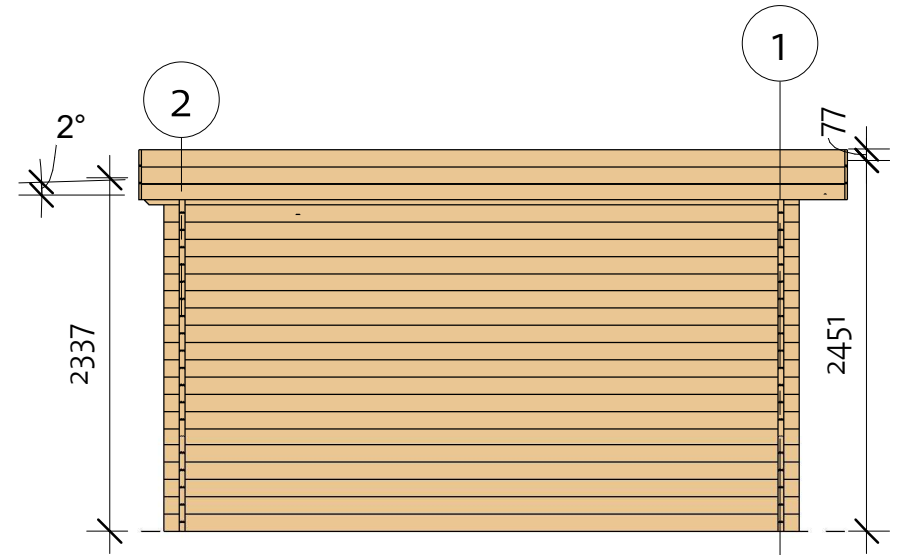
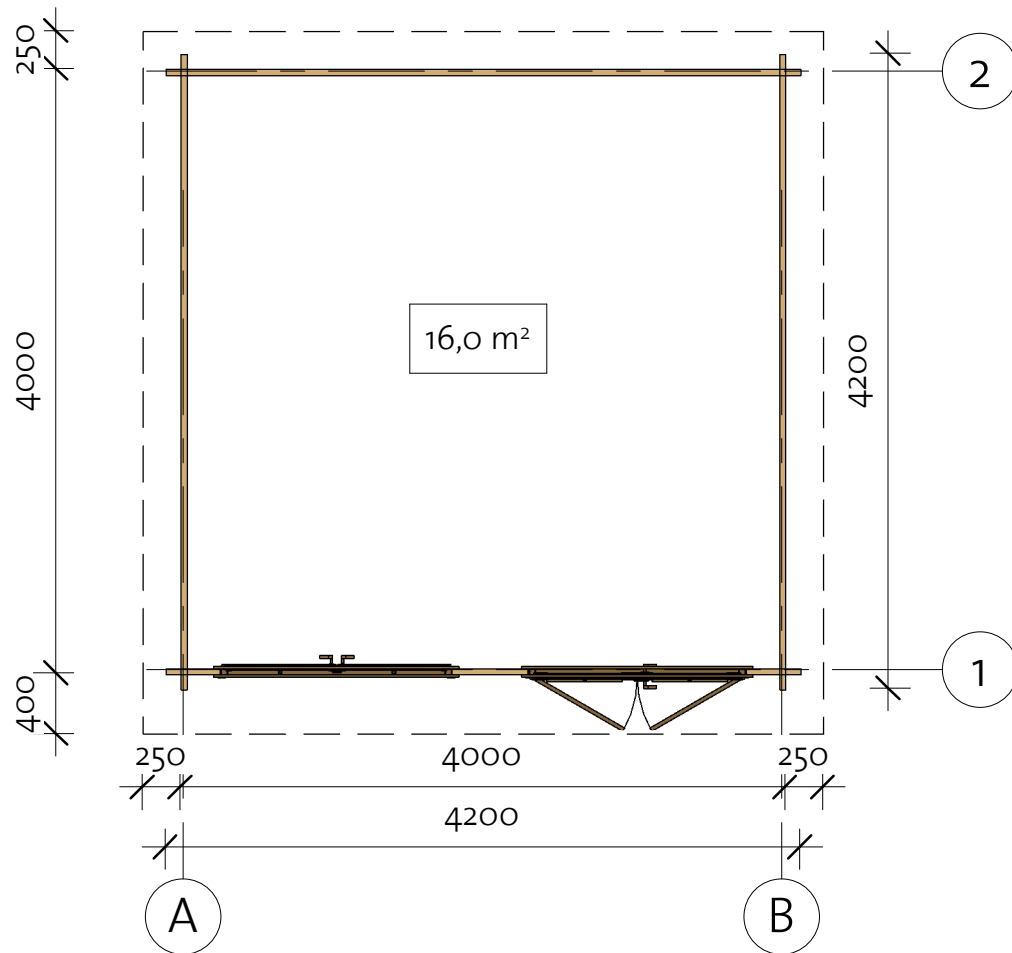
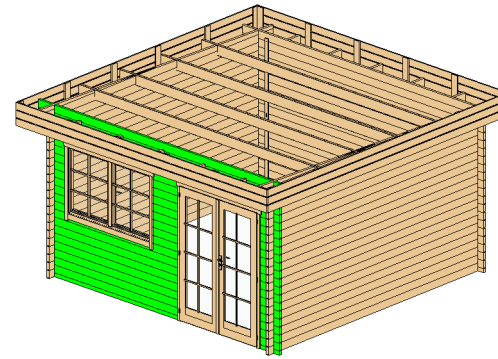

Wall 1			
Mark	Profile	Count	Cut Length

1BL 1	40X57	1	2400
1BL 2	40X57	1	360
1LG 1	40X114	8	2400
1LG 2	40X114	26	360
1LG 3	40X114	1	4500
1LG 4	40X114	9	500
1LG 5	40X114	2	4200
1TL 1	40X114	1	4500

Log Profile Wall 1	
Profile	Profile

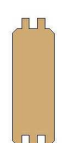
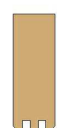
40X57	
40X114	
40X114	

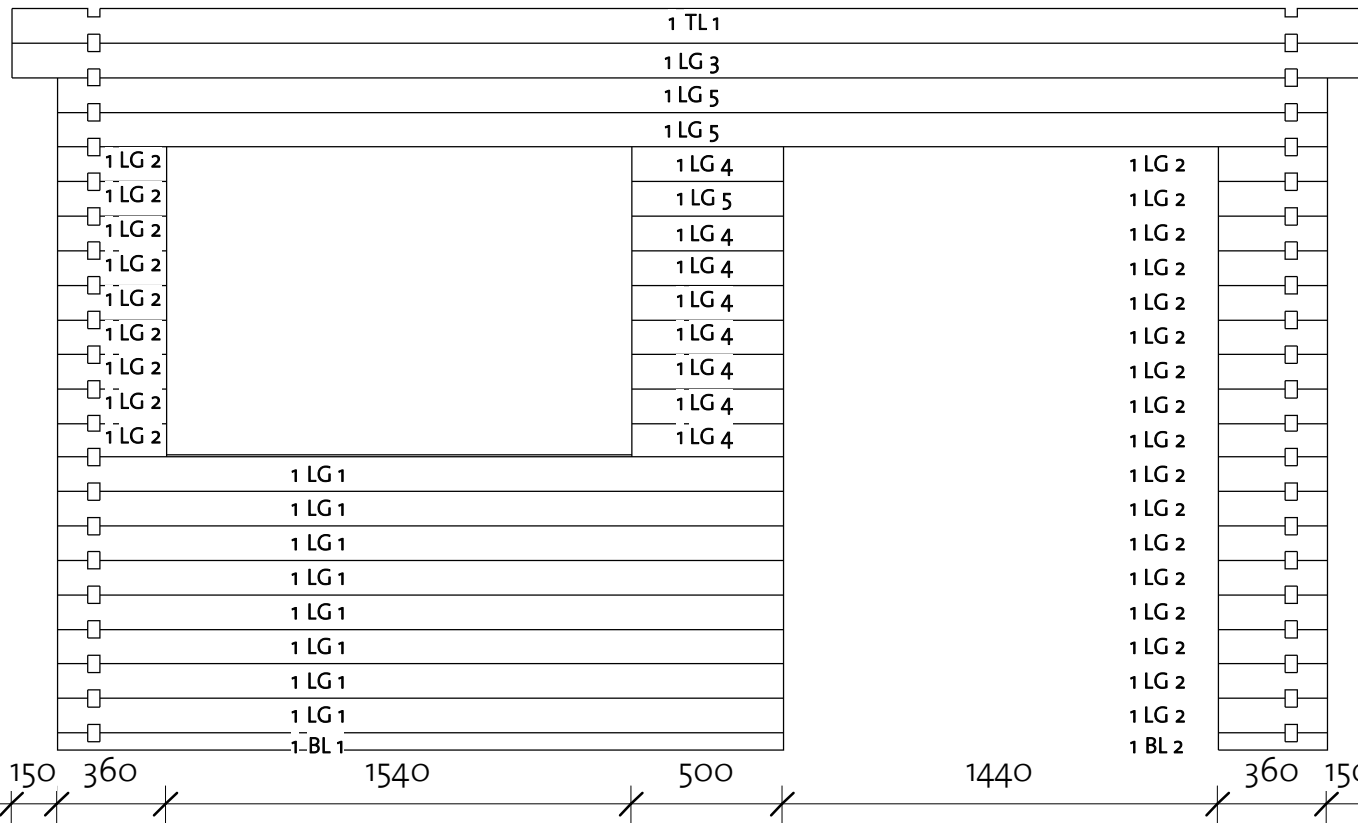

91905142_211101

Julia 40 (400x400)

Wall 2

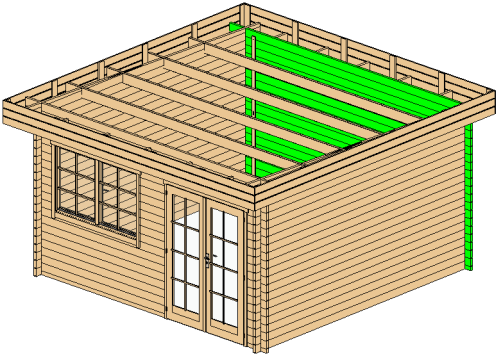

Wall 2			
Mark	Profile	Count	Cut Length

2BL 1	40X57	1	4200
2LG 1	40X114	19	4200
2TL 1	40X114	1	4500

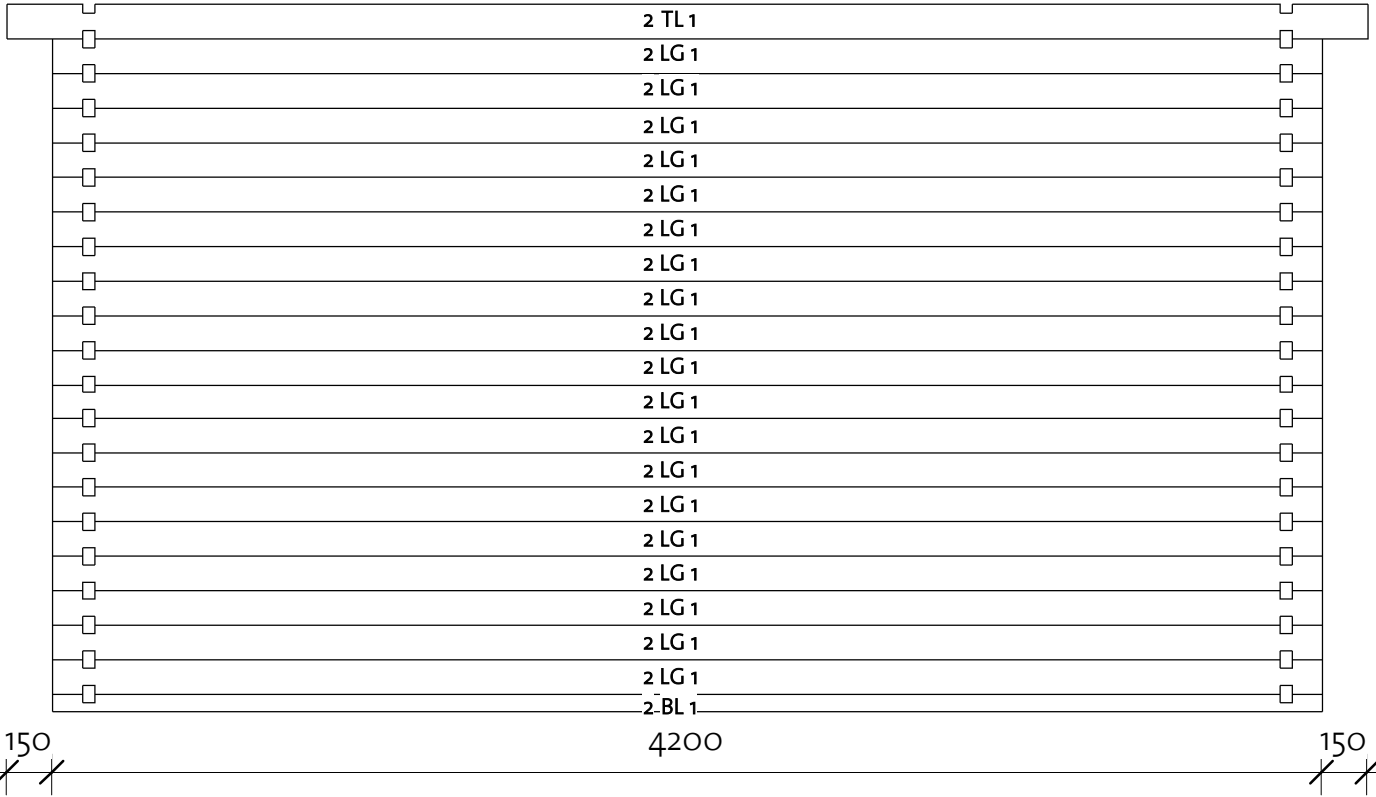

Log Profile Wall 2	
Profile	Profile

40X57	
40X114	
40X114	

Julia 40 (400x400)

Wall A

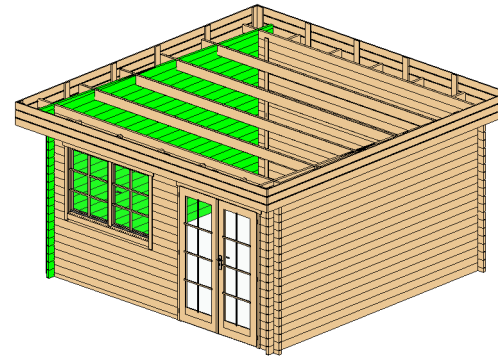

Wall A			
Mark	Profile	Count	Cut Length

ALG 1*	40x114	1	2380
ALG 2*	40x114	1	4650
ALG 3*	40x114	1	4350
ALG 4	40x114	19	4200

* Gable - delivered premounted

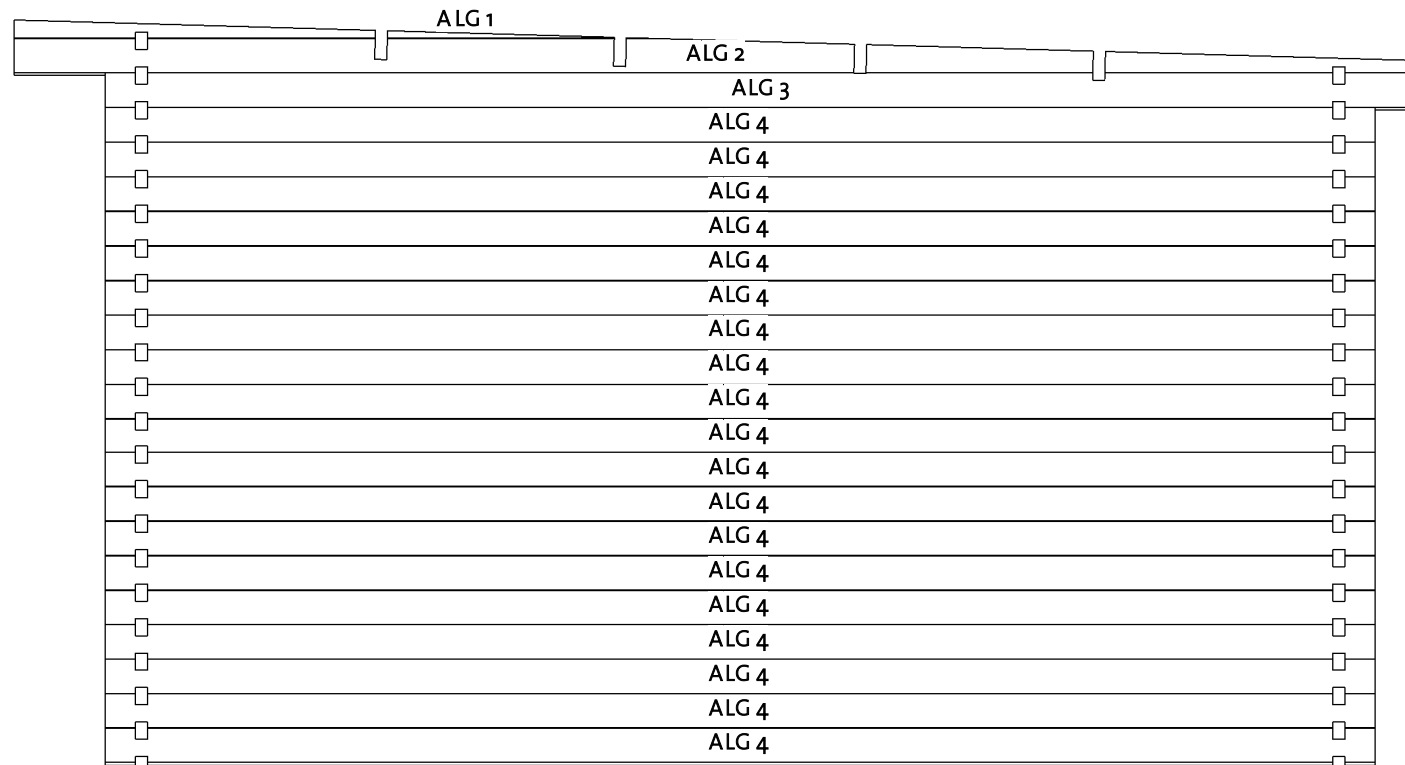

300
91905142_211101

4200

150

Log Profile Wall A	
Profile	Profile

40x114	
--------	--

Julia 40 (400x400)

Wall B

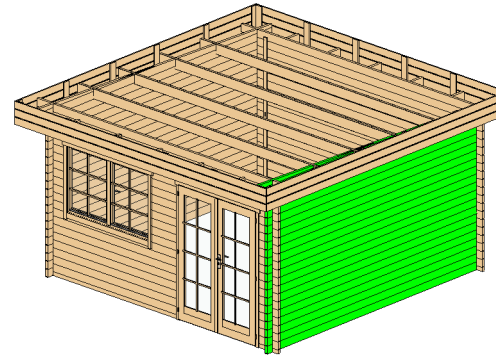

Wall B			
Mark	Profile	Count	Cut Length

BLG 1 *	40x114	1	2380
BLG 2 *	40x114	1	4650
BLG 3 *	40x114	1	4350
BLG 4	40x114	19	4200

* Gable - delivered premounted

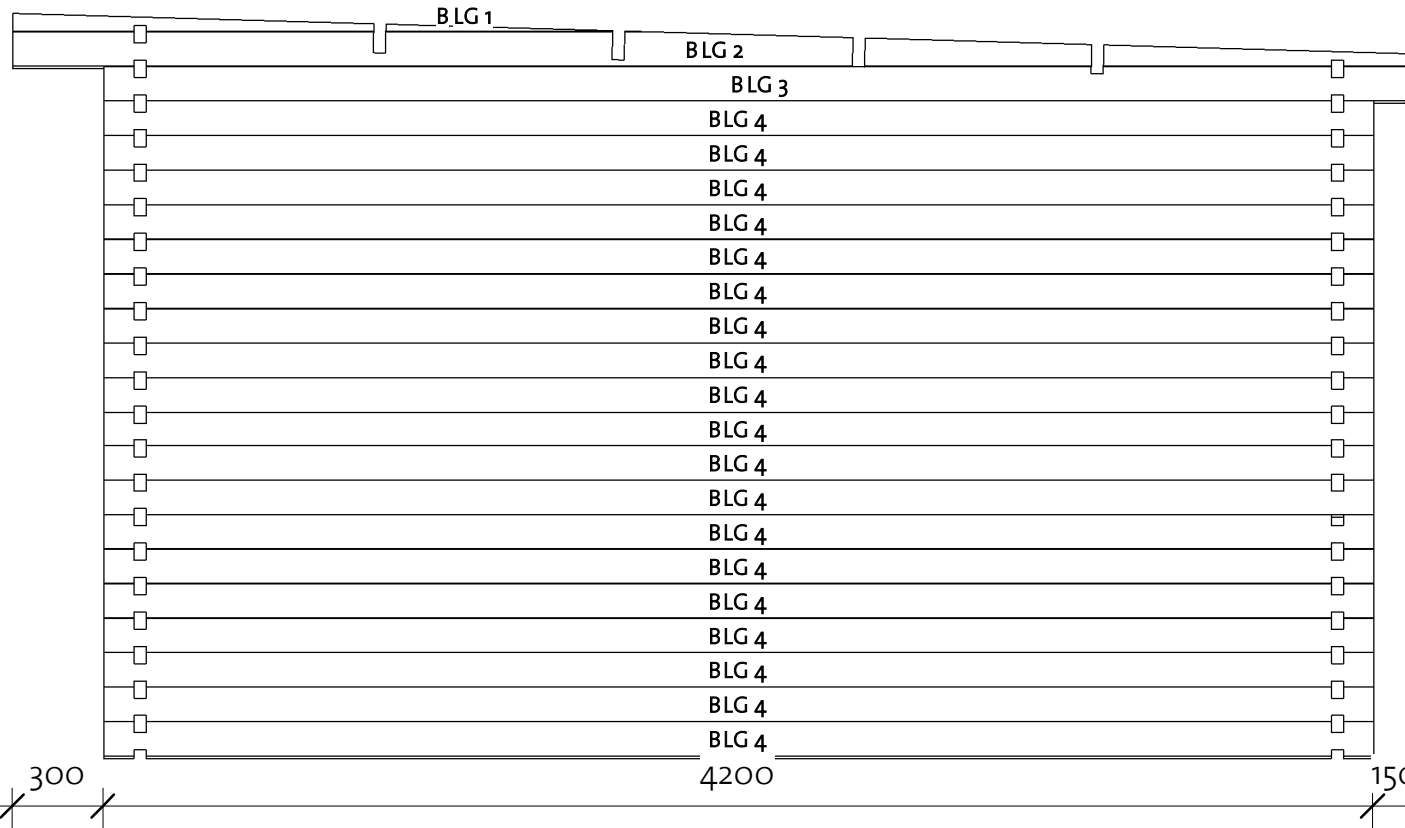

Log Profile Wall B	
Profile	Profile

40x114	
--------	--

Julia 40 (400x400)

Roof 1

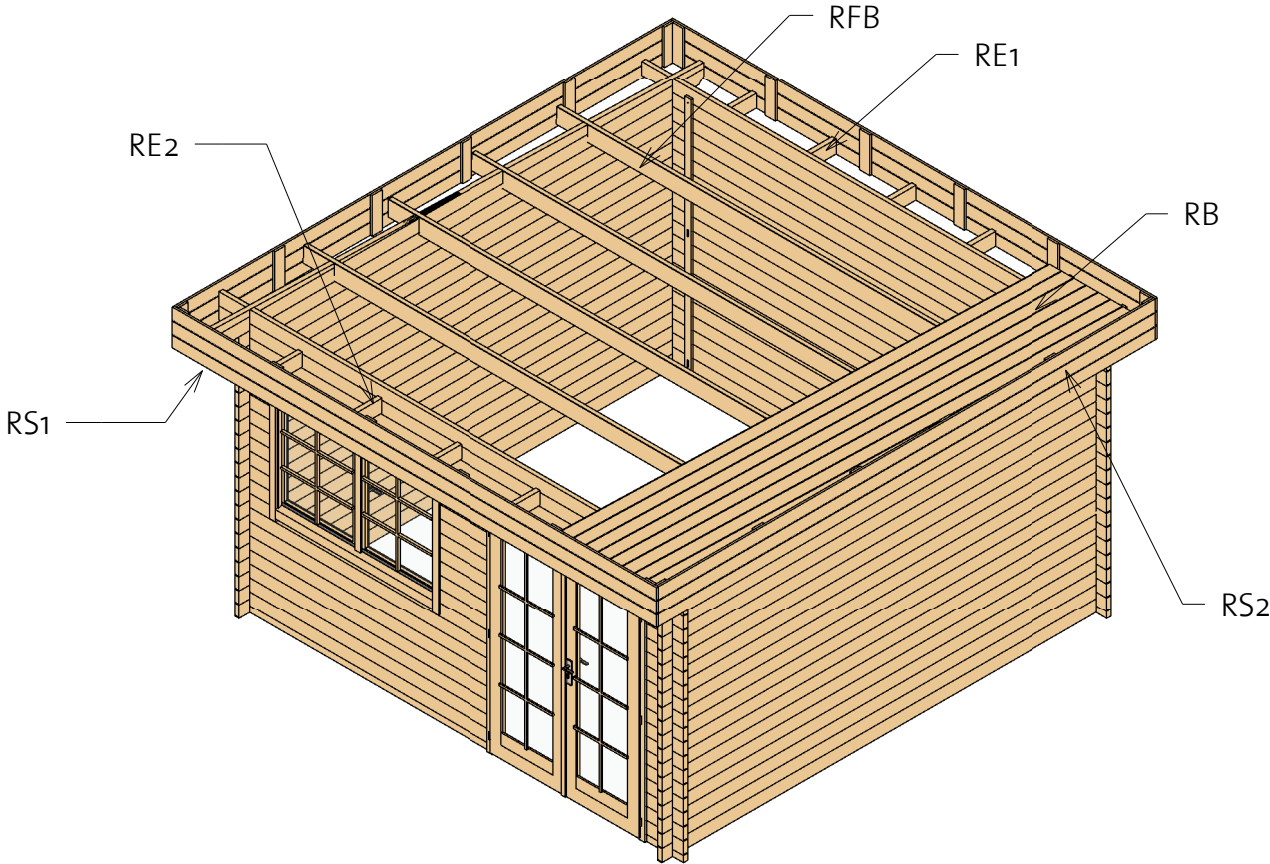

Roof				
Mark	Type	Profile	Count	Length
RB	17x114		40	4617
RE1	40x120		5	250
RE2	40x120		5	400
RFB	Beam 40x143		4	4500

Roof Side Schedule		
Type	Length	Count
RS1	4534	2
RS2	4650	2

Julia 40 (400x400)

Roof 2

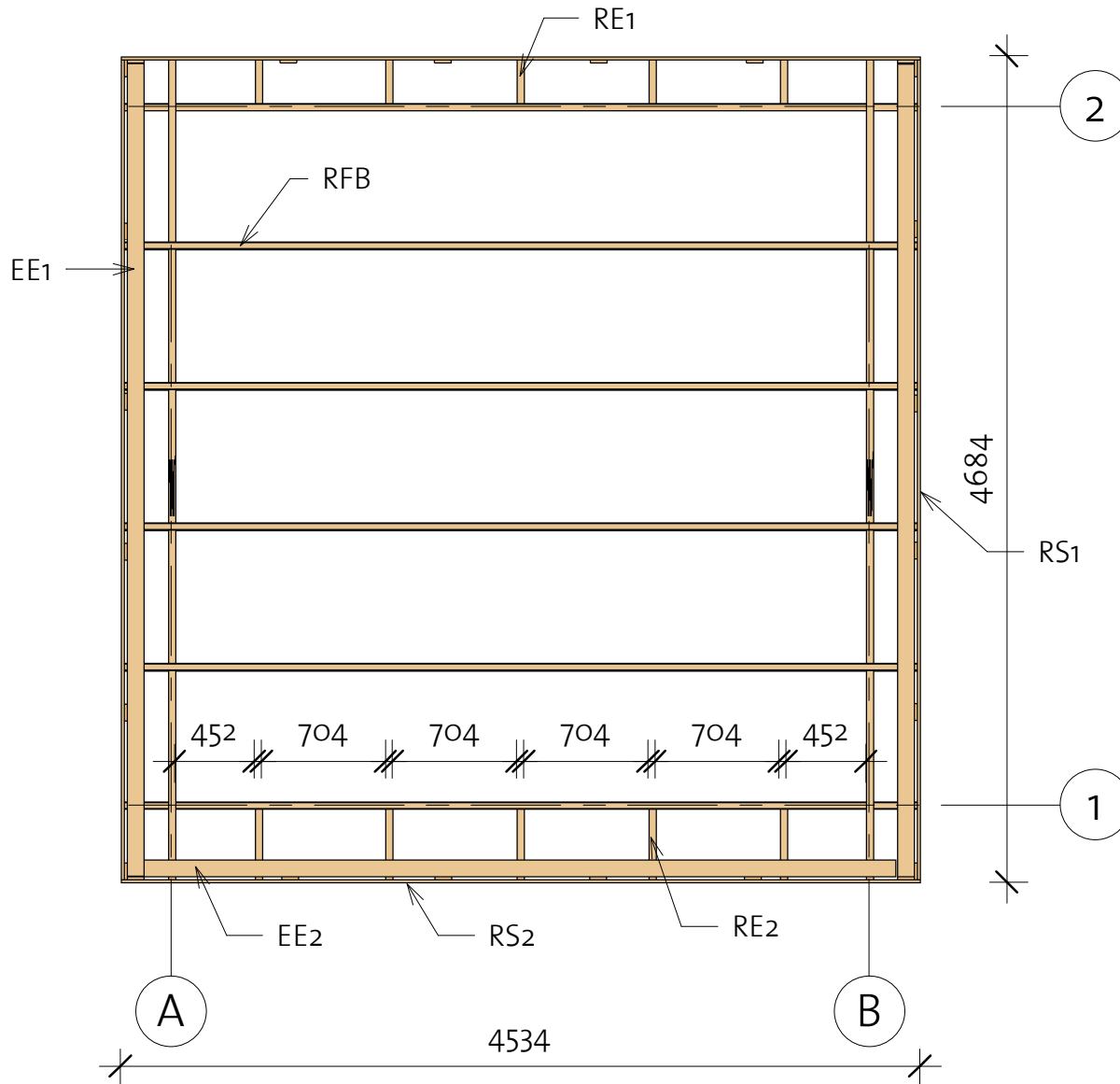

Fascia Schedule				
Mark	Type	Profile	Count	Length
EE1	Eave Edging 18x95		2	4610
EE2	Eave Edging 18x95		1	4265

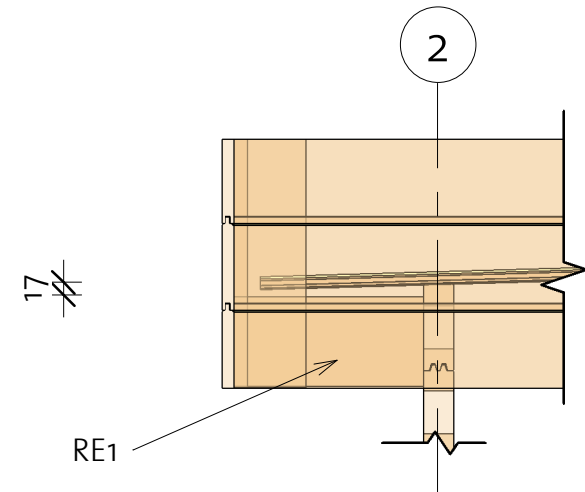

Julia 40 (400x400)

Extras

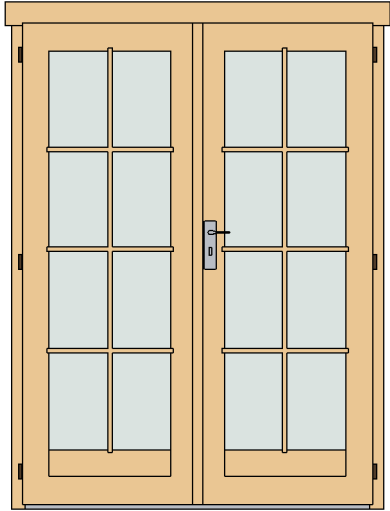

Door Schedule				
Model	Type	Width	Height	Count
CDD3R	Classic double door 3 right	1425	1955	1
DCB8	Door Crossbar 8	--	--	2

Windboard		
Type	Count	Length
Windboard 18x40 2350	2	2200
Windboard 18x40x2200	2	2200

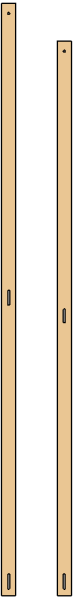

Fasteners & Extras		
Name	Type	Count



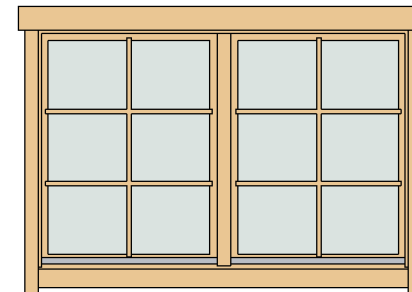

Hitblock	300-400 mm	
Bolts	M8 x 70	12
Screws	5,0 x 70	30
Screws	6,0 x 140	30
Screws	4,0 x 40	40
Screws	4,0 x 50	300

Window Schedule				
Model	Type	Width	Height	Count
CDW1	Classic double window 1	1530	990	1
WCB6	Windows Crossbar 6	--	--	2



Julia 40 (400x400)

List of all items 1

Roof				
Mark	Type	Profile	Count	Length
RB	17x114		40	4617
RE1	40x120		5	250
RE2	40x120		5	400
RFB	Beam 40x143		4	4500

Roof Side Schedule		
Type	Length	Count
RS1	4534	2
RS2	4650	2

Fascia Schedule				
Mark	Type	Profile	Count	Length
EE1	Eave Edging 18x95		2	4610
EE2	Eave Edging 18x95		1	4265

Julia 40 (400x400)

List of all items 2



Wall 1			
Mark	Profile	Count	Cut Length

1BL 1	40X57	1	2400
1BL 2	40X57	1	360
1LG 1	40X114	8	2400
1LG 2	40X114	26	360
1LG 3	40X114	1	4500
1LG 4	40X114	9	500
1LG 5	40X114	2	4200
1TL 1	40X114	1	4500

Wall B			
Mark	Profile	Count	Cut Length

BLG 1 *	40X114	1	2380
BLG 2 *	40X114	1	4650
BLG 3 *	40X114	1	4350
BLG 4	40X114	19	4200

Log Profiles	
Profile	Profile

40X57	
40X114	
40X114	

Wall 2			
Mark	Profile	Count	Cut Length

2BL 1	40X57	1	4200
2LG 1	40X114	19	4200
2TL 1	40X114	1	4500

Wall A			
Mark	Profile	Count	Cut Length

ALG 1 *	40X114	1	2380
ALG 2 *	40X114	1	4650
ALG 3 *	40X114	1	4350
ALG 4	40X114	19	4200

* Gable - delivered premounted